

Valmet Technical Paper Series

Roll Cover Developments: Tissue Press

Executive Summary

Tissue machines represent one of the most demanding applications when it comes to the press roll. The demands on tissue press roll covers are large, with high machine speeds, high loading frequency of the nips, and wear resistance in a challenging operating environment being critical factors.

Valmet's new polyurethane cover materials extend running periods and reduce maintenance and energy costs on tissue machines. At the same time, they maximize dewatering while providing constant nip conditions which leads to constant high tissue quality and optimal runnability.

This white paper reviews recent tissue poly cover developments, specifically the PressFox TIS, VacuFox TIS, PressHusky and VacuHusky covers. An analysis of the operating conditions in a tissue press is made, and a case study presented.

New press roll covers for tissue machines

The challenges

Tissue machines represent one of the most demanding application points when it comes to press roll covers. They are usually faster than machines producing printing paper and board. Their press rolls usually have a rather small diameter, leading to an extremely high loading frequency of the nips. The operating environment of the cover is challenging due to water, steam and the heat generated by the Yankee cylinder.

Furthermore, a great number of operational requirements are placed on the roll covers (**Figure 1**). For example, the suction roll nip acting as the 1st press must raise the dry content of the web to 40–45%. When it comes to runnability and quality requirements for tissue paper, the covers must be evenly hard and significantly softer than the covers used in machines producing printing paper or board. The pressure level in a nip formed with a soft cover is low, which is beneficial for paper thickness, for example.

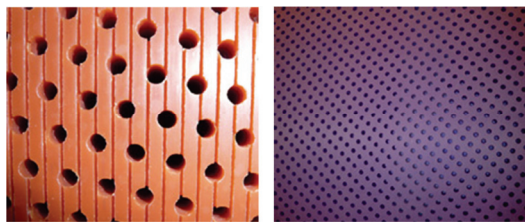
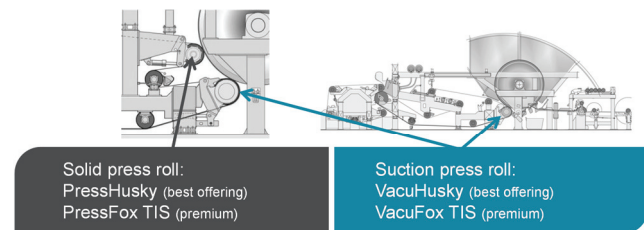

Figure 2. Valmet's VacuFox TIS roll cover (left) for press suction rolls and PressHusky roll cover (right) for press rolls

Polyurethane took over the press roll surface positions in printing paper machines a few decades ago. However, covers suitable for tissue machines have been more uncommon. In recent years, Valmet has actively developed new polyurethane materials suitable for tissue paper applications (**Figure 2**), and now these materials offer indisputable benefits when compared to older products on the market.

Note: Valmet's PressGator Z rubber cover is an economical option, with PressGator ZL being the best rubber cover available in the market. However polyurethane covers surpass even the best rubber covers in multiple performance areas.

The best possible wear resistance (**Figure 3**) and even hardness are the most important qualities in the process conditions that the suction



Requirements for suction press and solid press roll covers

- Dewatering and water handling capacity (especially suction press)
- Cover loading resistance and low heat generation under load (especially solid press rolls)
- Cover stability (hardness), durability, and long lifetime (all press rolls)

Figure 1. Primary applications and challenges for tissue press roll covers

The aforementioned factors often lead to short grinding intervals due to wearing or changes in cover hardness, an insufficient dewatering capacity and cooling problems related to the roll in the 2nd nip. In addition, other problems have been caused by sudden debonding of roll covers especially in the press roll in the 2nd nip.

Unbeatable wear resistance

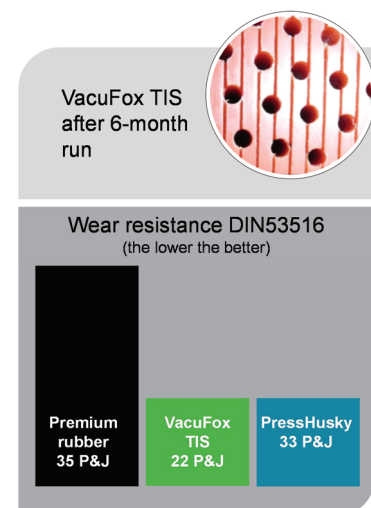

Figure 3. The new poly roll covers offer unbeatable wear resistance.

roll and press roll positions in tissue machines are subjected to. The wear resistance of Valmet's modern polyurethane materials is unbeatable. Their grinding intervals can be twice as long as traditional covers.

Hardness remains even

Besides nip loading, the roll cover's ability to deform under load determines dewatering efficiency, tissue quality and profiles. A harder cover offers higher nip pressure effective dewatering and high tissue strength. On the other hand, a softer cover offers lower nip pressure and a longer nip, with higher tissue bulk and thickness and better compatibility with the Yankee.

The new products do not harden in use like most traditional rubber covers; instead, the hardness remains even despite the demanding operating conditions. When it comes to hardness, most polyurethane coatings are applied using a different P&J value compared to traditional rubber coatings. This does not mean that they act differently in a pressed nip, but the material's response to the P&J hardness measurement is different. In general, when polyurethane is applied with identical P&J hardness compared to rubber, the poly will give lower nip pressure and a longer nip.

Volume-driven producers will look for the most efficient dewatering; a cover that is too soft may cause problems. In cases where tissue quality (i.e. thickness) is important and machines are prone to profile issues, a softer cover may be necessary.

In tissue paper applications, traditionally only holes have been made on the suction and press roll covers to reach a sufficient water handling capacity. The strength properties and softness of the covers have set limits for grooving, and cracking in the neck areas between the grooves as well as groove closures have been noted earlier on grooved covers. In Valmet's new polyurethane materials, a high strength level and special groove geometry enable using grooves also in soft covers.

The water handling capacity reached by using grooves is important especially in suction roll positions where the roll cover handles most of the water. As dewatering in the roll nip is intensified, the need to dry the paper with the heat energy of the Yankee cylinder decreases, resulting in lower production costs.

Lower maintenance and energy costs

Press rolls traditionally equipped with internal water cooling have posed probably the biggest challenge for the technical features of the covers. Cooling has been essential in order to prevent overheating of the cover due to the viscous nature of the cover materials. One common problem has been the cooling effect of the water cooling system on the roll body. As a result, water manages to enter the cover and make its way between the connecting layers. This has often led to sudden debonding of the cover.

Water cooling created unfavorable thermal gradient; the roll body is cool compared to the process water. Driven by the thermal gradient, water penetrates through the cover thickness, from warm towards cold (**Figure 4**). Water accumulation/channeling to the cover/shell interface leads to catastrophic bonding failure.

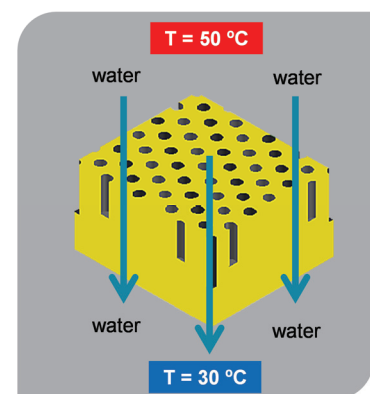

Figure 4. Internal water cooling creates undesired thermal gradients leading to deterioration of the cover/shell bond.

Valmet's new polyurethane cover designed especially for press rolls generates only a fraction of the heat usually generated in the press nip when using traditional materials. The internal water cooling of the roll is not needed even at high speeds, and coating problems related to cooling are thus eliminated. Water cooling becoming unnecessary leads to considerable savings in the form of reduced maintenance and pumping costs, for example.

Furthermore, the rolling resistance of the cover in the nip is lower, meaning that the energy need of the drive motors running the rolls decreases and thereby energy costs are also reduced.

Optimized dewatering is a team effort

Of course, the roll cover alone is not the only factor to be taken into account in the dewatering process. Truly optimized dewatering requires teamwork between the roll cover, doctoring method and machine fabrics (**Figure 5**). For example, the ValDual doctor blade for soft covers and the CombiDoc doctoring system are recommended for the new polyurethane covers. Additionally, the SprintMaster and TransMaster Open felts provide superior water removal capabilities when functioning with Valmet's poly covers.

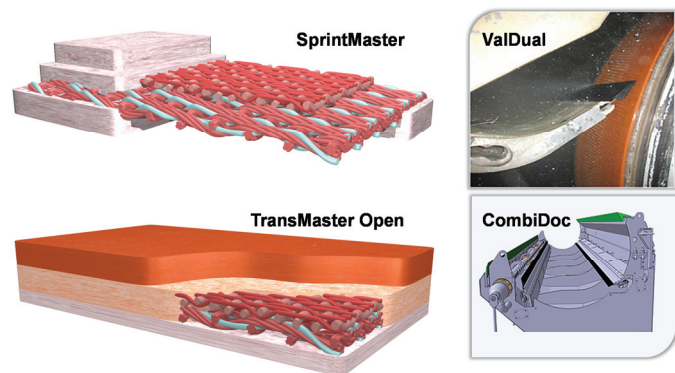

Figure 5. Optimal dewatering requires the best combination of roll cover, doctoring method and machine clothing.

Metsä Tissue Mänttä switches to polyurethane covers in press rolls

Over the years, the Metsä Tissue Mänttä mill in Finland has also become familiar with many of the aforementioned cover problems and challenges often encountered on tissue machines. Valmet and Metsä Tissue have a long history of collaboration in roll maintenance and roll cover development projects.

Valmet delivered the first VacuFox TIS polyurethane cover to the Mänttä mill at the end of 2010. A cover equipped with suction holes and grooves was installed in a press suction roll position on PM 9 in January 2011 and the cover functioned flawlessly for a full operating period of one year.

The roll cover was noted to be in extremely good condition during service grinding in January 2012. The operating period of earlier covers in the position in question had usually been six to eight months.

After a successful start new polyurethane covers were introduced to other roll positions as well. Valmet has subsequently delivered five new-generation polyurethane covers to the tissue machines in Mänttä. One of the covers was installed in a press suction roll and four in the press rolls in the 2nd nips.

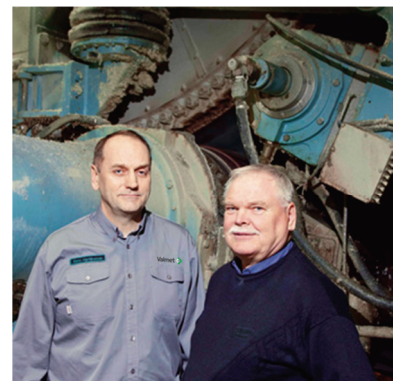

Figure 6. Reijo Vessari from the Metsä Tissue Mänttä mill (right), and Eero Hartikainen from Valmet (left) are pleased with the new roll covers' performance.

"Valmet's polyurethane covers have worked well and met our expectations. The most significant benefits have been longer grinding intervals and the elimination of roll cooling in the 2nd press positions," Process Engineer Reijo Vessari from the Metsä Tissue Mänttä mill explains (**Figure 6**, previous page).

Furthermore, the softness of the covers has proved to be beneficial with regard to paper thickness.

Thanks to their positive experiences, Metsä Tissue plans to replace all traditional rubber covers with new-generation polyurethane covers as the rolls are recovered.

Metsä Tissue Mänttä in short

Metsä Tissue belonging to the Metsä Group produces tissue and cooking papers. The company's mills are located in Finland, Sweden, Germany, Slovakia, Poland and Russia.

The Mänttä mill, established at the end of the 19th century, has four paper machines. PM 1, PM 9 and PM 10 produce tissue papers and PM 7 cooking papers.

The tissue machines represent the two-nip concept where the 1st nip is formed by a press suction roll located against a Yankee cylinder and the 2nd nip by a press roll located against a cylinder. The performance of the machines has been enhanced by several rebuilds, the latest of which was carried out on PM 10 in 2010.

PressFox TIS and VacuFox TIS polyurethane roll covers for tissue machine press section rolls

The Fox family of covers are mainly intended for suction press rolls (VacuFox TIS). It is also possible to use them in 2nd press roll positions (PressFox TIS), normally with internal water cooling. The primary advantages of the Fox covers are in the areas of drying energy, runnability and cover lifetime.

Superior dewatering performance

Drying energy savings are achieved through superior press dewatering. The strong cover material facilitates maximal open area and great void volume. The grooved cover offers the best water removal potential.

Special Valmet grooves (**Figure 7**) deliver the most effective water removal due to groove cleanliness and openness. Grooving is especially important for suction press rolls. With a single-roll press configuration (suction press roll only), adding a grooved cover may reduce the consumption of Yankee steam by several percent. With a two-roll press configuration, the effect of a grooved 2nd press roll will probably be smaller.

Valmet optimizes the surface pattern of the grooved roll for effective water removal (**Figure 8**, next page). The strong material facilitates maximal open area and great void volume for high levels of dewatering – with up to 46% open area available. Valmet's special groove design prevents groove closure. The cover is available in through-drilled, blind-drilled and grooved styles.

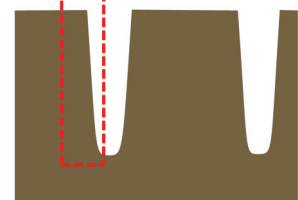
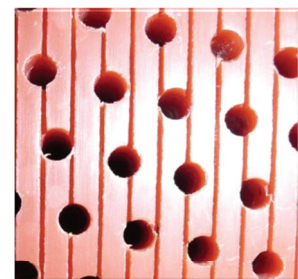

Figure 7. Valmet special grooving method is more effective.

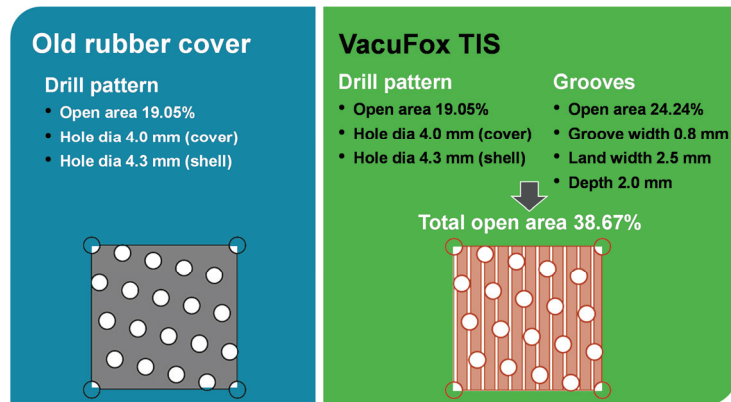

Figure 8. Typical drilling and grooving patterns for a suction press roll

Excellent runnability

The VacuFox TIS and PressFox TIS covers provide excellent runnability. The stability of hardness within 1 P&J guarantees the best cross-direction nip pressure. There is no post-application hardening, even during long running periods in wet and hot conditions. Rubber covers tend to harden, whereas the Fox covers actually soften a bit in use.

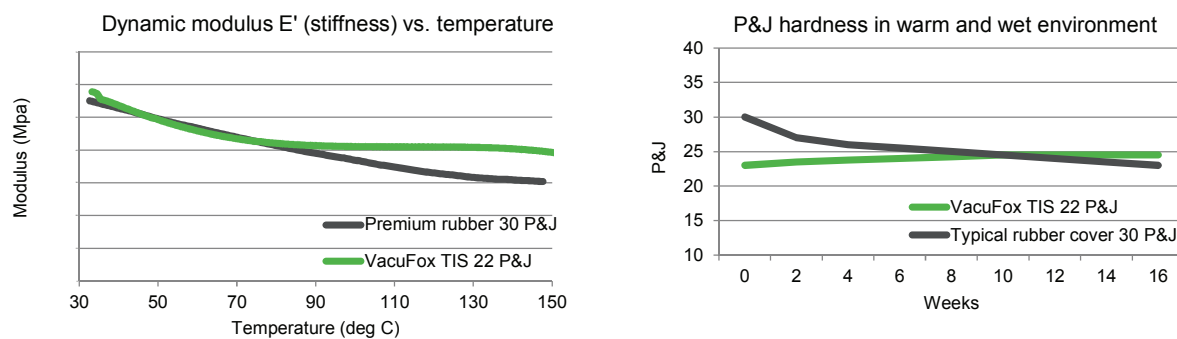

Figure 9. Comparison of rubber and VacuFox TIS covers, stiffness and hardness

Despite their different P&J hardness, their dynamic modulus is equal, i.e. 22 P&J for VacuFox TIS equals 30 P&J for rubber in the nip (Figure 9).

Longer cover lifetime

These covers offer extended regrinding intervals and cover service life. This is due to the ultimate wear resistance offered, and the exceptionally durable bonding, which also yields highly dependable safety, and the strength and durability of the material.

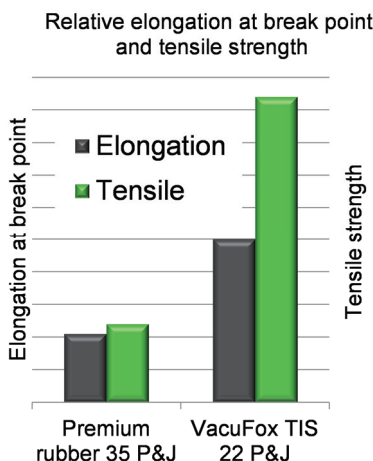

Figure 10. Fox covers are stronger and more resilient than premium rubber covers.

The Fox covers are more than four times stronger than premium rubber covers (Figure 10). High tensile strength facilitates more open area and more void volume. The cover is stronger than paper wads, reducing lifetime costs. Fox covers withstand paper wads and other nip incidents significantly better.

The abrasion rate of Fox covers is 1/3 the rate for premium rubber (Figure 11). This results in longer regrinding intervals, fewer roll changes and lower maintenance costs.

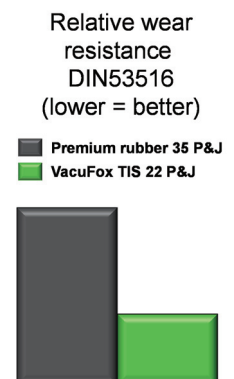

Figure 11. PressFox TIS and VacuFox TIS offer significantly better wear resistance.

Valmet's new PressHusky and VacuHusky polyurethane roll covers improve tissue quality

The new PressHusky and VacuHusky roll covers are designed especially for Yankee press applications widely used in dry crepe tissue production. As an option, a Valmet iRoll online nip profile measuring system can be applied with these new roll covers. The Husky tissue press roll covers exceed the operating capabilities of the Fox family of covers and are the best and most advanced covers available.

New polyurethane material enables enhanced tissue quality and control of dewatering efficiency

Some tissue grades are sensitive when it comes to bulkiness and thickness so lower nip pressures are preferred in pressing. Traditionally, this has been a limitation in the use of polyurethane roll covers in Yankee press applications. However, the new polyurethane material of PressHusky and VacuHusky covers offers several hardness alternatives and more options for cover topography, which results in maximized dewatering and the desired tissue quality with high bulkiness and thickness.

Their low rolling resistance creates energy savings thanks to reduced roll drive power.

Figure 12 shows the calculated cover internal friction power of a premium rubber roll vs. the PressHusky polyurethane roll at a mill after switching from rubber to PressHusky. Note that the calculated reduction in internal friction power with PressHusky is 4-8 kW,

depending on machine speed and other factors. At the mill in question, the resulting 7 kW power difference corresponded to an annual savings of 60 MWh. The actual reduction in drive power requirements will vary depending on the previous roll used, but it should decrease with PressHusky.

PressHusky and VacuHusky covers also provide lowered operating costs due to the reduced need for regrinding. This, combined with improved dewatering and reduced drive energy requirements, will easily make a return on investment.

Figure 13 shows an example calculation comparing a rubber cover (PressGator Z) with the PressHusky poly cover. In this instance, Improved dewatering gave 1.00% improvement in post-

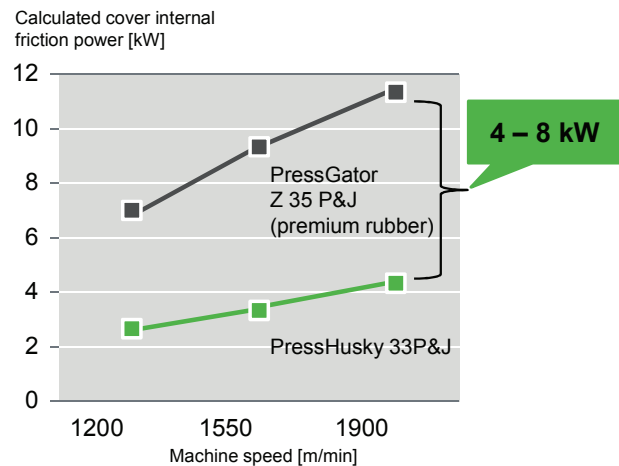

Figure 12. PressHusky's lower rolling resistance equates to savings in drive energy.

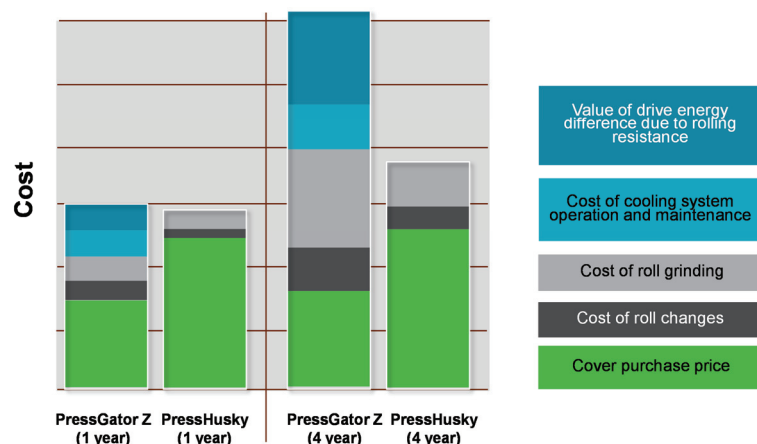

Figure 13. Roll cover purchase and operation costs after one and four years of use

press dryness at 65,000 t/a production levels. As you can see, the payback in this example was one year, with even greater differences looking at longer term comparisons. And this doesn't take into account other benefits of PressHusky and VacuHusky, including better uniformity, increased tissue bulk and decreased broke.

Benefits of PressHusky and VacuHusky material

Most versatile options for cover typography and hardness:

- Maximized dewatering
- Desired and constant tissue quality
- Best runnability

Minimal heat generation and low rolling resistance under dynamic load:

- No need for internal cooling
- Energy and maintenance savings
- Reduced risk of cover failure

Superior abrasion resistance, strength and hardness stability:

- Long service life
- Constant nip conditions

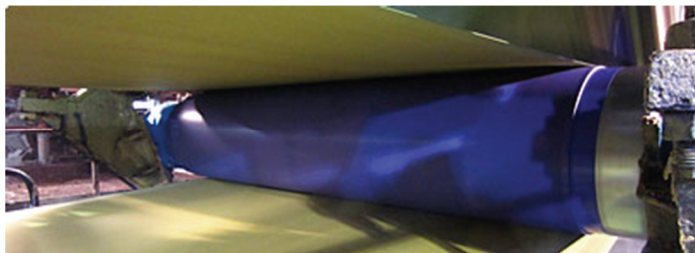

Figure 14. A PressHusky roll cover equipped with an iRoll online nip pressure measuring system in action on a Yankee dryer

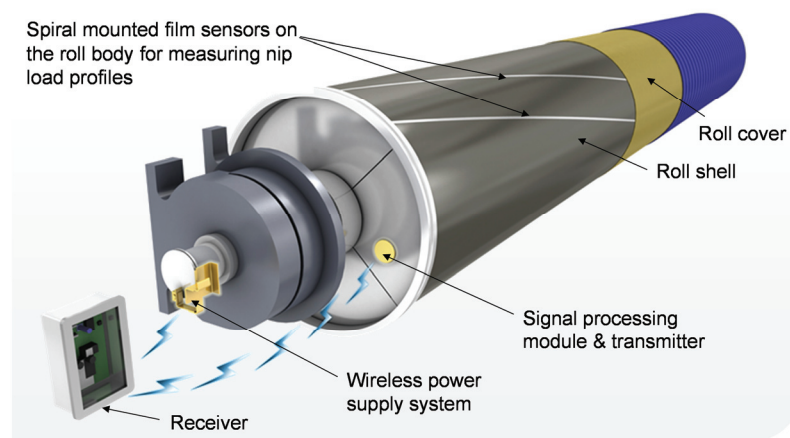

Figure 15. iRoll helps to fix skewed nips or crowns and is available in embedded or portable options.

Online roll profile measurement with intelligent roll

Nip profile monitoring and control has been quite a challenge in a nip formed between a roll and a Yankee dryer. Reliable information on nip profile errors or skewness problems can only be gained when measurements are taken at

operating speed with the desired steam pressure inside the Yankee dryer. Valmet's iRoll measurement technology (Figures 14 and 15) can be utilized with these new polyurethane roll covers, providing accurate nip pressure profile data for efficient nip control.

The example computer screen display shown is for an iRoll reference installation with

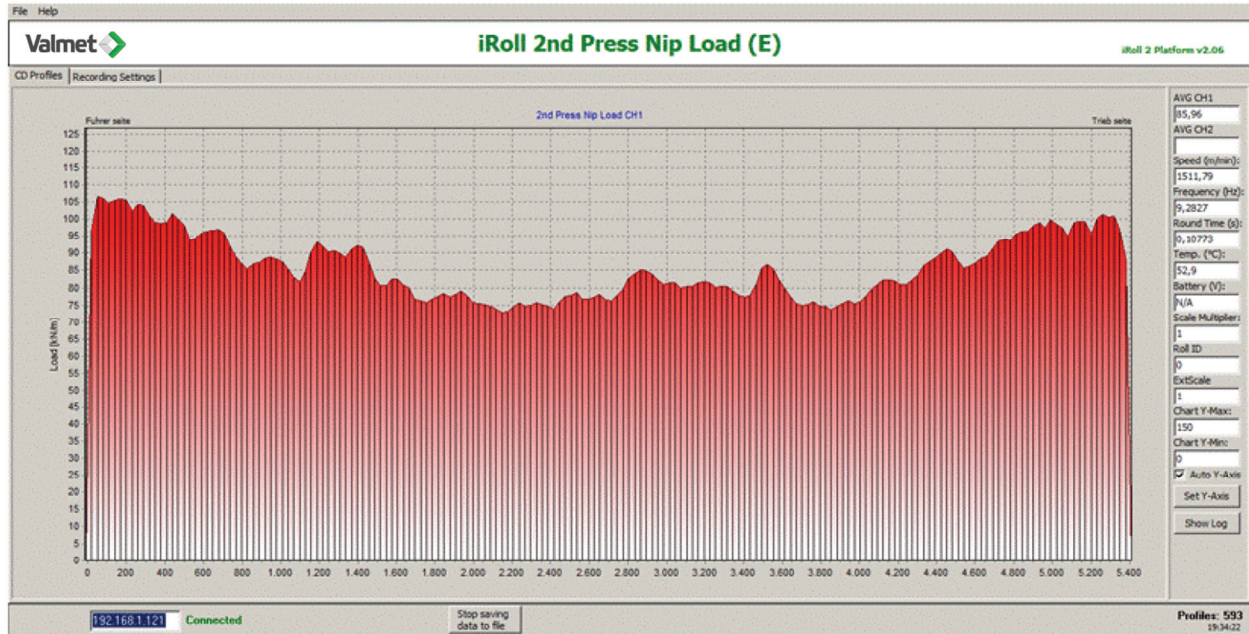

Figure 16. This example iRoll screen shows overloading at ends of PressHusky nip. It is viewable in real-time by the operator, allowing prompt corrective actions to be taken before damage to the end product or roll cover.

PressHusky (Figure 16). The online nipload measurement confirmed overloading in the ends which was causing runnability problems. In this case, iRoll provided essential information for the roll/Yankee crown and nip loading control which had not been available before. The iRoll identification of root-cause ensured fast, accurate and effective corrective actions were taken.

Comparison of the new polyurethane covers

Table 1 shows that many of the specifications for Fox and Husky family of covers are equivalent except for hardness, where PressHusky and VacuHusky are harder covers.

The base layer is a composite material and the thickness is 6.0 mm. On solid rolls, the minimum distance from the groove / BD-hole bottom to the shell / cover interface is 9.0 mm. The minimum cover thickness before recovering is 10 mm (this value can be used when calculating cover lifetime).

Typical groove depth is originally 2.0 mm and re-grooving is needed when remaining groove depth is ~1.0 mm (varies from 0.7 to 1.4 mm). An original 20.0 mm thick cover can be typically re-grooved twice.

Cover	Hardness (P&J)	Cover thickness (inches)	Max. temp. (°F)	Max. nip pressure (psi)	Application notes
PressFox TIS	10-25	5/8 to 1	200	1700	Tissue machine press roll
VacuFox TIS	10-25	5/8 to 1	200	1700	Tissue machine suction press roll
PressHusky	12-33	5/8 to 1	200	1700	Tissue machine press roll
VacuHusky	12-33	5/8 to 1	200	1700	Tissue machine suction press roll

Table 1. Roll cover specifications for the new poly roll covers

Summary

The challenges presented in the tissue machine press section are significant: high machine speeds, high loading frequency in the nips, and wear resistance in a challenging operating environment. Valmet's new poly covers for tissue mills are making a positive difference in mills in over 50 countries, running on several grades, basis weights and machine concepts (DCT/WCT, single nip, double nip). The return on investment is reasonably quick, due to the maximized dewatering, longer regrinding intervals, decreased energy requirements, constant nip conditions and lack of need for internal cooling.

This white paper combines technical information obtained from Valmet personnel and published Valmet articles and papers.

Valmet provides competitive technologies and services to the pulp, energy and paper industries. Valmet's pulp, paper and power professionals specialize in processes, machinery, equipment, services, paper machine clothing and filter fabrics. Our offering and experience cover the entire process life cycle including new production lines, rebuilds and services.

We are committed to moving our customers' performance forward.